



small head = DIN ISO 2009, 2010, 7046-1, 7046-2, 7047

* not included

Further parts see page 12B-120
– Key

Cam lock

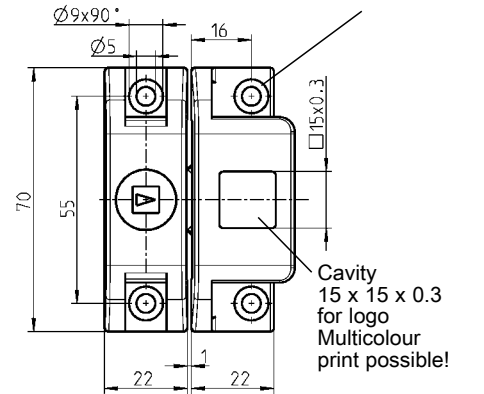
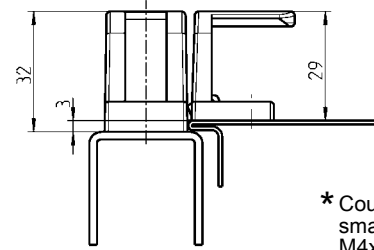
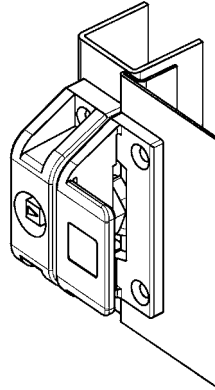

Cam lock polyamide black, insert zinc die chrome pl. cam, screw and wave washer m.s. zinc pl.

Square 7	1076-U5	Double bit 3	1076-U9
Square 8	1076-U6	Double bit 5	1076-U10
Triangular 7	1076-U7	Hexagon female SW 10	1076-U11
Triangular 8	1076-U8	Slot 2 x 4	1076-U12

Snap lock with and without seal

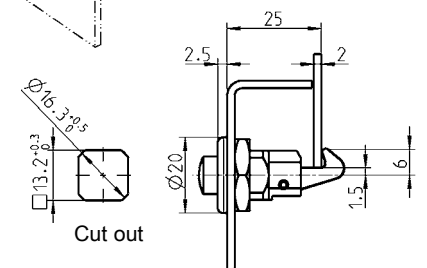
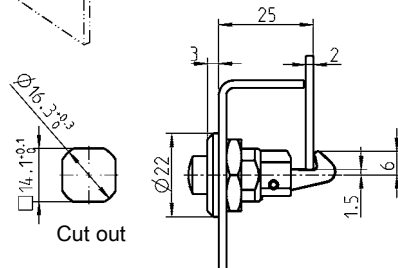
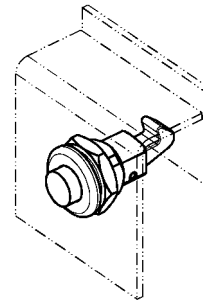
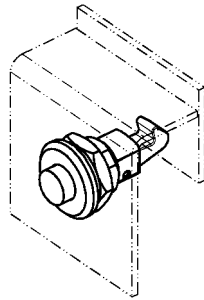

Version A

Version B

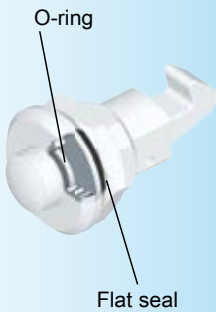

with seal IP 65

Snap lock zinc die chrome plated, without or with seal

Version A		Version B	
without seal	1047-U3	without seal	1047-U2
with seal IP 65	1047-U5	with seal IP 65	1047-U4