



Info

1 Quarter turns

2 Rod controls

3 Locking systems

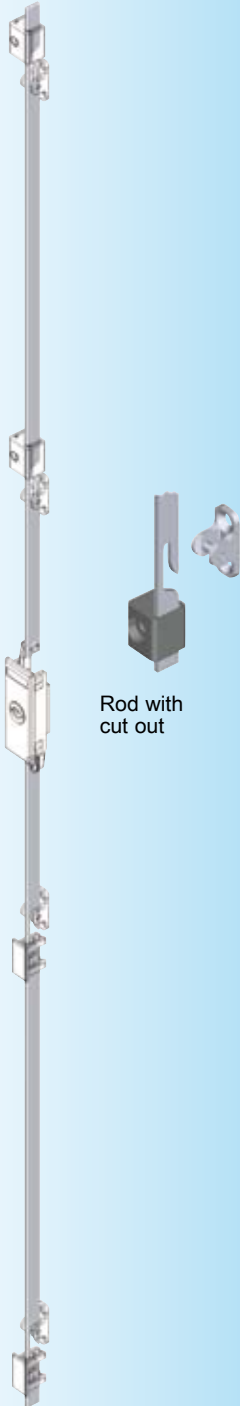

Rod with cut out

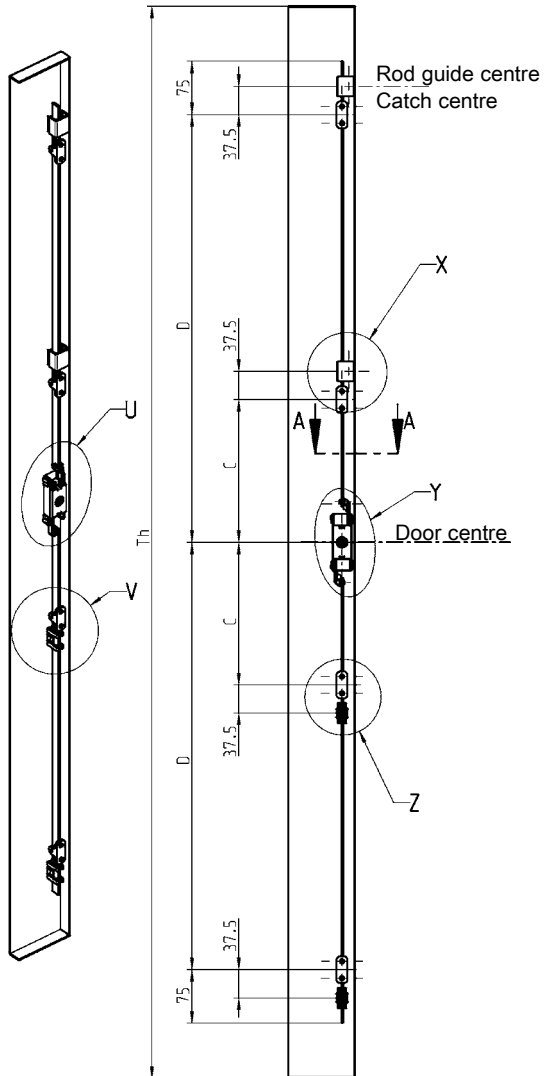
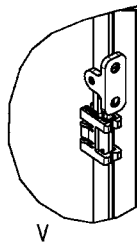
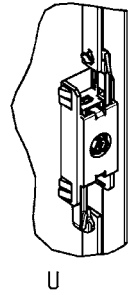

Inside door representation

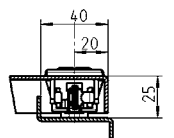
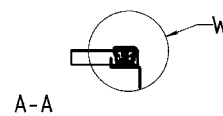
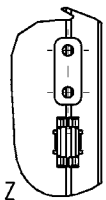
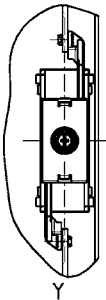
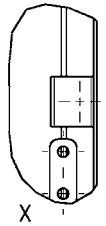

Bending area

W

Further parts see page

- Catches 3ZA-1220
- Rod guide 3ZC-120 to 3ZC-170

Program 2300

- Escutcheon 3J-120

Door height	Locking points (door centre)		Part no. Rods Upper and Lower	
	Dim. C	Dim. D	m.s. zinc pl.	AISI 304
Th				
800-1200	-	300	2300-06-11RA	on request
1200-1600	-	450	2300-06-13RA	on request
1600-1900	275	700	2300-06-15RA	on request
1900-2200	275	850	2300-06-17RA	on request