

- Info
- 1 Vorreiber
- 2 Slangenschlösser
- 3 Verschluss-Systeme
- 4 Schamiere
- 5 Dichtungen
- 6 Griffe
- 7 Aufsatzfenster
- 8 Edelstahl
- 9 Spannverschlüsse
- 10 Klimabau
- 11 EMKA Electronics
- 12 Diverses

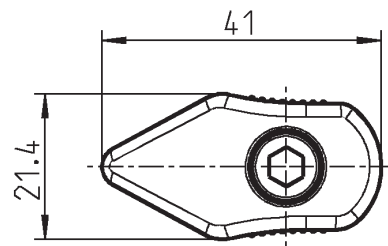

Klemmbügel Polyamid GF schwarz;
Zylinderschraube St verzinkt; mit Feder

1076-U13

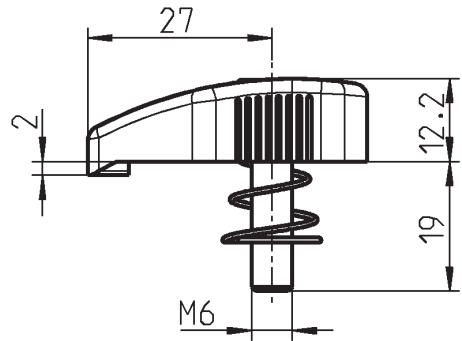
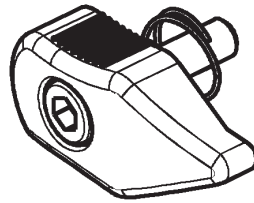
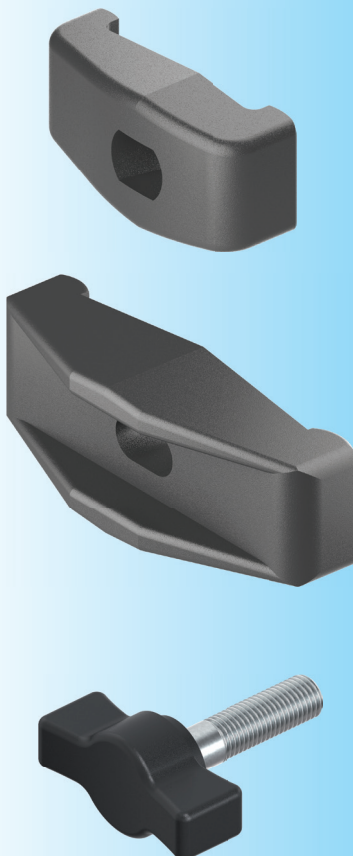

Ausführung A

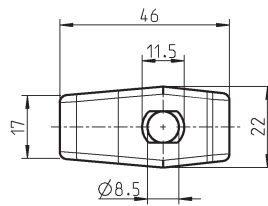

Ausführung B

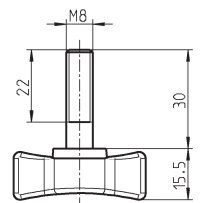
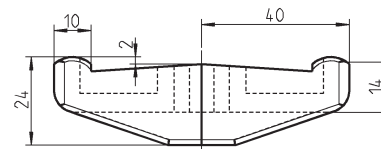
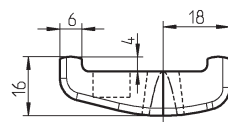
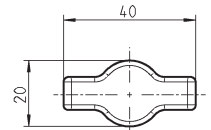
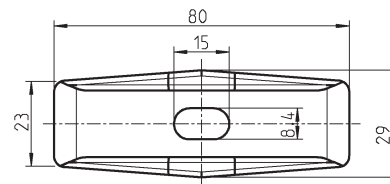

Klemmbügel Polyamid GF schwarz

Ausführung A

Ausführung B

1076-19

1076-20

Knebelschraube St verzinkt; Knebel Polyamid GF schwarz

1076-15